



**AMAZONE**

# Precea





# Precea precision air seeder

Designed for precision without compromises!



When seeding after the plough, in mulch or direct seeding, the Precea precision air seeder particularly excels with its very accurate placement, high workrates and comfortable operability. The first-class singling and fertiliser metering system convinces even at working speeds of up to 15 km/h. The various frame concepts ensure maximum flexibility.



# Precea

accurate – quick – comfortable

|  | Page |
|--|------|
| The benefits at a glance                                       | 4    |
| The models   | 6    |
| Frame versions   | 8    |
| Precea-A harrow-mounted precision seeder                       | 10   |
| Seed hopper  | 12   |
| Singling   | 14   |
| Centralised singling drive                                     | 16   |
| PreTeC mulch sowing coulter                                    | 18   |
| PreTeC coulter options   | 20   |
| Fertiliser application   | 22   |
| FerTeC twin double disc fertiliser coulter                     | 24   |
| Micro micro-granular applicator                                | 26   |
| Optional equipment   | 28   |
| Operation  | 30   |
| ISOBUS   | 32   |
| ISOBUS   Job management  <br>GPS-Maps   GPS-Track   agrirouter | 34   |
| ISOBUS   GPS-Switch  | 36   |
| ISOBUS   ISOBUS terminals                                      | 38   |
| Technical data   | 42   |

❗ “The first impression of the Precea regarding handling and level of technology is good.”

(“profi” – Driving report for Precea 4500-2CC Super · 10/2019)



# Precea

The high-speed precision air seeder

Fertiliser hopper in either

**950 l** or **1,250 l**

In **3 m** and **4.5 m** working widths

**4 to 8** sowing units,  
each with **55 l** hopper capacity

Row spacings of **45 cm** to **80 cm**

## The benefits at a glance:

- ⊕ Accurate seed placement due to excellent overpressure singling with short propulsion channel
- ⊕ Even spacing due to the catcher roller
- ⊕ Even field emergence due to appropriately shaped and reconsolidated seed furrow by the furrow former
- ⊕ High work rates with working speeds of up to 15 km/h
- ⊕ Low lifting power requirements for the tractor due to the optimised centre of gravity
- ⊕ Accurate and active fertiliser metering in each row using the Precis individual fertiliser metering system
- ⊕ Simple and intuitive operation via ISOBUS
- ⊕ Comfortable and tool-free adjustment of the seed drill
- ⊕ Simple and tool-free exchange of the centralised singling disc, even with the seed hopper filled







Up to **15 km/h**  
working speed



FOR FURTHER INFORMATION  
[www.amazone.net/precea](http://www.amazone.net/precea)

# Precea precision air seeder

accurate – quick – comfortable

## A seeder in a class of its own

With the Precea, AMAZONE offers a precision air seeder that meets the highest requirements. The new, high-performance centralised singling drive and the first-class PreTeC mulch sowing coulters are perfectly matched. Both systems work almost independently of the speed and the field conditions. The high seed placement accuracy impresses from the first to the last grain. So does the intuitive and convenient operation of the precision air seeder.

### The benefits:

- ✔ Accurate seed placement
- ✔ Excellent depth control with accurate sowing depth
- ✔ High work rates due to working speeds of up to 15 km/h
- ✔ More comfort due to the very simple adjustment of the singling and coulters

## The models

With its various framework concepts, this is a precision air seeder that is up for any challenge. The two equipment versions, Special and Super, as well as the harrow-mounted Precea-A with the QuickLink quick coupling system means that there is always the right choice. The Precea is available in 3 m and 4.5 m working widths and with row spacings of 45 cm to 80 cm.



Harrow-mounted Precea 3000-ACC  
with KG 3001 Special rotary cultivator



Linkage-mounted Precea 4500-2CC





### Precea Special

AMAZONE offers the Special version of the Precea precision air seeder with SpeedShaft mechanical central singling drive and a mechanical fertiliser metering drive with stepless Vario gearbox. The Precea Special impresses with its very accurate placement, even at working speeds of up to 12 km/h.

| Model                 | Number of rows | Frame execution                       |
|-----------------------|----------------|---------------------------------------|
| Precea 3000 Special   | 4, 5, 6        | rigid                                 |
| Precea 4500 Special   | 5, 6, 7, 8     | rigid                                 |
| Precea 4500-2 Special | 6, 7           | Single and 2-fold telescopic function |



✔ With SpeedShaft mechanical central singling drive

### Precea Super

The Precea Super version has ElectricDrive electric centralised singling drive and an electric fertiliser metering drive to provide maximum convenience. Due to the electric metering and centralised singling drive, the quantity of seed or fertiliser can be very quickly and easily changed in the operator terminal. At working speeds of up to 15 km/h, the Precea impresses with its high work rates.

| Model               | Number of rows | Frame execution                                 |
|---------------------|----------------|---|
| Precea 3000 Super   | 4, 5, 6        | rigid   |
| Precea 3000-A Super | 4, 5, 6        | mounted   |
| Precea 4500 Super   | 5, 6, 7, 8     | rigid   |
| Precea 4500-2 Super | 6, 7           | Single, 2-fold and variable telescopic function |



✔ With ElectricDrive electric drive



# The frames

More flexibility. The right solution for any requirement



The harrow-mounted precision seeder

## Uncomplicated and robust

Due to the closed-coupled design, all the frame options with the precision air seeder are very light and compact. The maintenance-free bearings on the frame with telescopic function provide quality and reliability. The unique bearing concept of the telescopic frame minimises wear and tear and keeps surface abrasion to a minimum.

### The benefits:

- ✔ Fast and convenient to extend in and out
- ✔ Low lifting power requirement for the tractor
- ✔ Maximum residual value preservation due to the maintenance-free bearings

## Flexibility from 45 cm to 80 cm

Row spacings of 45 cm to 80 cm are possible, depending on the requirements and the machine model.



The Precea 4500-2CC with its variable telescopic frame at full working width



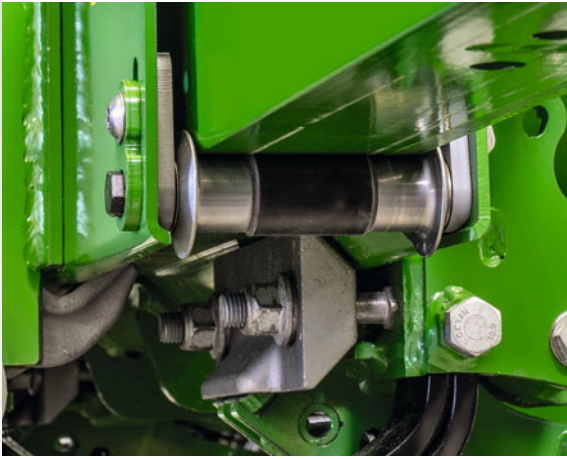

✔ Maintenance-free bearings on the telescopic frame

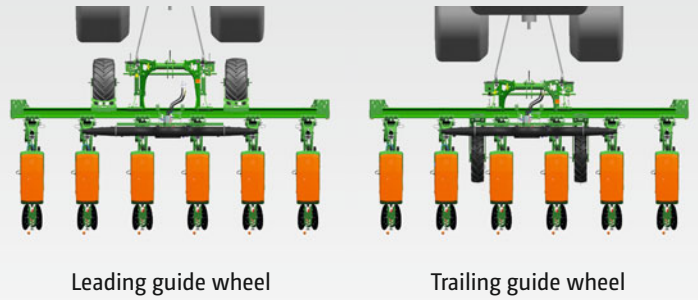

### Telescopic control – single and 2-fold telescopic frame

AMAZONE offers two different frame options, one with single and one with 2-fold telescopic function. The frame with single telescopic function is cheaper and has a transport width of 3.3 m. The 2-fold telescopic frame has a transport width of 3 m and therefore ensures safe road transport. The unique bearing concept with maintenance-free bearing ensures a long lifespan and makes folding and extending the frame particularly convenient.

### Different guide wheel options

The Precea has two guide wheel options that can be mounted ahead of or between the seeding units. Guide wheels in front of the mounting frame offer the full spectrum of row spacing, however, the very compact option of between the seeding units impresses with a clearly reduced lifting power requirement.

### The variable telescopic frame

The variable telescopic frame allows flexible and convenient adjustment of the row spacing to suit different crops. Different row spacings are therefore a problem of the past.

### Quickly ready for action

The Precea frame is limited just to the essentials. For example, the telescopic frame offers real operational comfort. Extend the frame at the press of a button quickly, reliably and conveniently either out or back together.

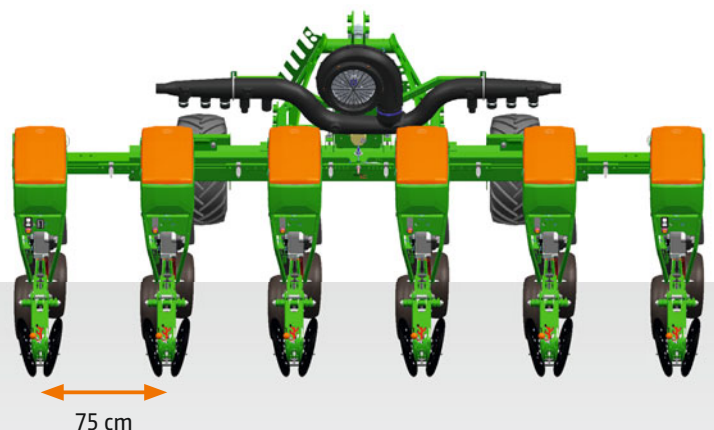

The variable telescopic frame on the Precea 4500-2 and 4500-2CC

# Precea-A – the harrow-mounted precision seeder

The correct soil tillage leads to a successful sowing combination

## Precision sowing and seedbed preparation in just one pass!

The Precea harrow-mounted precision seeder can be optionally combined with the KX rotary cultivator or the KG rotary cultivator. Due to its combination with a soil tillage implement, this sowing combination provides perfect seedbed preparation and seeding in one pass.

## QuickLink quick release coupling system – faster, simpler mounting and demounting

Thanks to the QuickLink quick release coupling system of the Precea-A, this precision air seeder can be easily and quickly linked to the various AMAZONE seedbed cultivators without the need for tools.

Rotary cultivator KX  
or rotary cultivator KG

with roller

- ✔ PW tooth packer roller
- ✔ TRW trapezium roller
- ✔ KW wedge ring roller or
- ✔ KWM wedge ring roller with Matrix tyre profile



Precea-A harrow-mounted  
seed drill





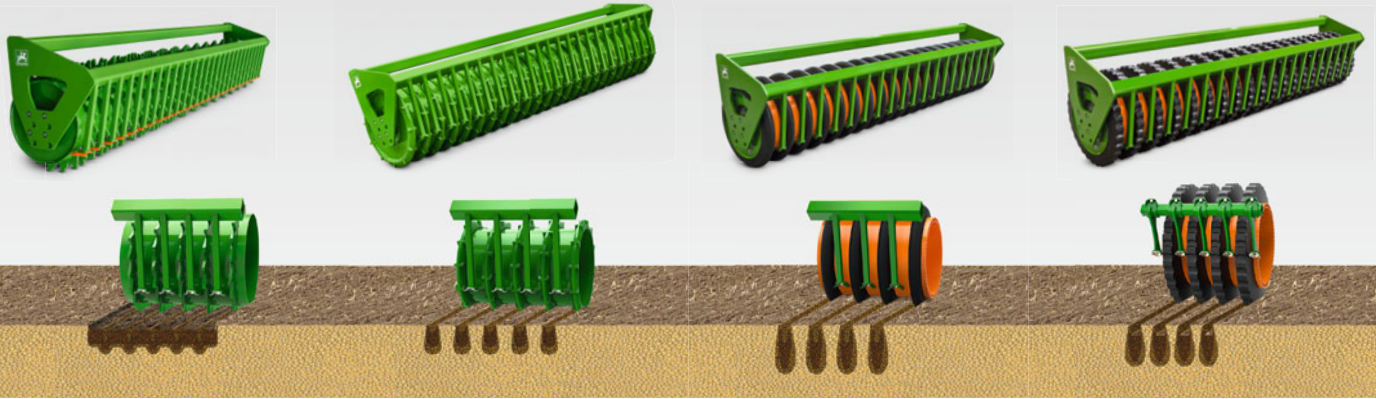

PW tooth packer roller/  
600 mm

TRW trapezium roller/  
500 mm/600 mm

Wedge ring roller KW/  
520 mm/580 mm

KWM wedge ring roller  
with Matrix tyre profile/  
600 mm

## Wide roller programme – for any location the right roller

With various models of roller available, it is possible to specify a complete unit of soil tillage and drill that are perfectly matched to the prevailing soil conditions.

**i** More detailed information can be found in the separate product brochure available from your sales partner



KX 3001 rotary cultivator



QuickLink in Trio: Precea 3000-ACC Super, KG 3001 Super, Centaya 3000 Super



# Maximum precision. Maximum yield. Maximum success







The highest precision



For perfect plant emergence

## The seed hoppers – comfortable filling. Simple emptying

The seed hoppers each hold 55 l and are very easy to fill. The hopper lids can be conveniently opened with one hand, so that they can easily be filled from bags. A filling aid that guides the seed safely into the hopper and makes the filling process even easier is optionally available. Emptying of residual amounts is particularly quick, easy and clean.

The low level sensor fitted as standard indicates the fill level on the terminal at an early stage.

### The benefits:

- ✔ Good accessibility
- ✔ One handed operation of the lid makes the filling process easier
- ✔ Clever and clean emptying of residual amounts from both sides by using the seed chute



- ✔ The seed hoppers hold 55 l, are easily accessible and facilitate one handed operation



- ✔ Emptying of residual amounts is particularly quick, clean and easy. And that can even be done from both sides.

# The singling

Accurate seed placement, more yield

## Reliably singled

The singling system works by using the overpressure principle. The pressure pushes the grain against the nap holes in the rotating centralised singling disc so that they are driven round. As they rotate, the grains under pressure pass three stripper fingers which reliably ensure the singling of the grains on the disc. Excess grains are reliably stripped off, so that any doubles are effectively prevented. This is particularly important for the seed placement accuracy.

## The smart highlight:

Due to the thoughtful design of the centralised singling unit, the singling disc and the singling pressure chamber are firmly connected to each other.

### The advantages of this layout are huge:

- ✔ The torque is clearly lower than in conventional systems
- ✔ The seal, which is otherwise subject to excessive wear, is not loaded



- ❗ “As the pressure chamber rotates in step with the perforated disc, energy-consuming friction on the pressure chamber seal can be avoided.”

(“profi” – Driving report for Precea 4500-2CC Super · 10/2019)

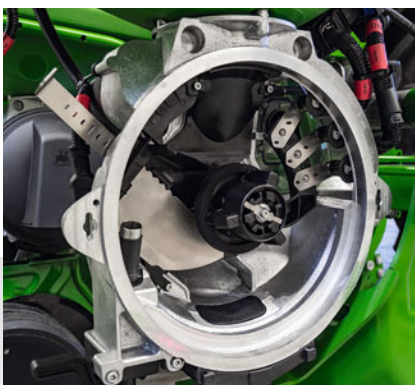

View of the metering unit without singling disc



Singling disc in place while stationary



Singling disc in operation (without lid)



# More comfort is not possible!

## Well-designed and clever

The Precea offers many advantages, particularly due to the intelligent layout of the combined rotating singling chamber.

- ✔ Tool-free change of the centralised singling disc
- ✔ Simple and convenient emptying of residual amounts from either side

## Reliably placed

As soon as the seeds reach the propulsion channel, the overpressure is interrupted and the seed is shot into the propulsion channel. In the seed furrow, which has been cleanly shaped and freed from organic matter by the furrow former, the grain is positioned by the catcher roller and pressed into the soil. This prevents unintentional rolling along of the grain and also ensures optimum seed/soil contact.

### Advantages of singling:

- ✔ Reliable singling almost independent of speed
- ✔ Universally applicable
- ✔ Avoids any misses and doubles

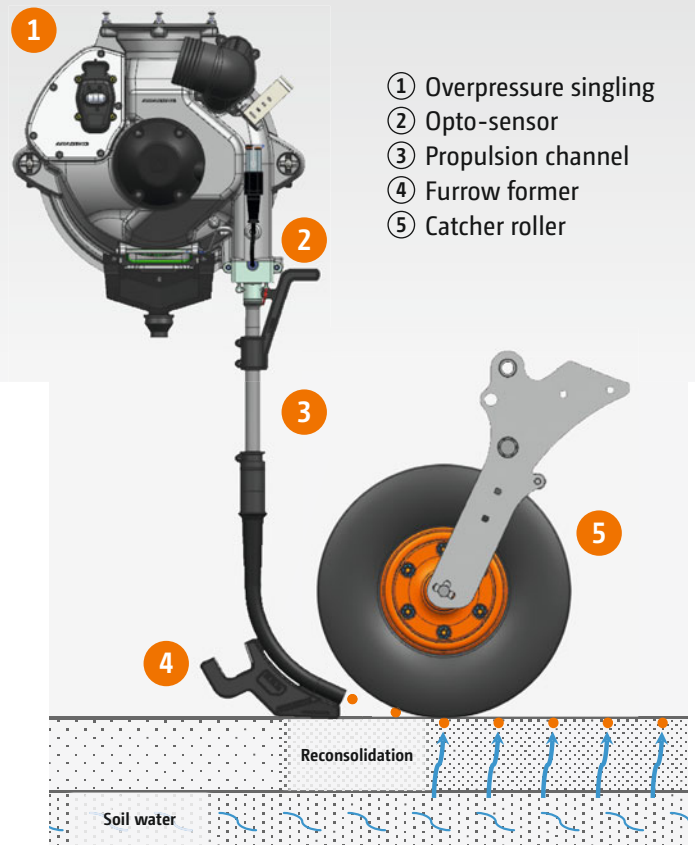

- ① Overpressure singling
- ② Opto-sensor
- ③ Propulsion channel
- ④ Furrow former
- ⑤ Catcher roller

- ❗ “The propulsion channel can be detached for without tools cleaning.”  
 (“profi” – Driving report for Precea 4500-2CC Super · 10/2019)

## All at one glance!

The standard optical sensor means excellent checking and monitoring from the tractor terminal. Whether rape or maize, the optical sensor is universally usable and does not need to be exchanged.



- ✔ Numerous centralised singling discs allow sowing of maize, sunflowers, rape, soya beans, sugar beet, etc.
- ❗ “The singling unit can be opened without tools and the sowing disc can be quickly exchanged in this way.”  
 (“profi” – Driving report for Precea 4500-2CC Super · 10/2019)



## Mechanical stripper adjustment for the Precea Special

The mechanical stripper finger setting allows fine adjustment of the strippers in order to optimise the seed placement accuracy. Doubles and misses are thus avoided, which increases the yield.

## Electric stripper finger adjustment for the Precea Super

The electric stripper adjustment allows convenient setting of the scrapers from the operator terminal in the tractor cab.

## SmartControl – automated stripper finger adjustment for the Precea Super

In order to relieve the stress on the driver and avoid unintentional misses and doubles, AMAZONE offers the optional, SmartControl automated stripper finger adjustment for the Precea Super.

### The benefits:

- ✔ The stress on the driver is reduced, as SmartControl handles the adjustment of the seed strippers
- ✔ Increase in yield, as doubles and misses are avoided
- ✔ Time savings, as manual setting can be omitted



- ✔ The mechanical stripper finger setting allows easy setting of the strippers per coulter



- ✔ The SmartControl automated stripper finger adjustment takes over the setting of the strippers and removes a considerable burden from the driver.



- ✔ SpeedShaft mechanical singling drive with working speeds of up to 12 km/h



## SpeedShaft mechanical singling drive for the Precea Special

The SpeedShaft mechanical drive facilitates forward speeds of up to 12 km/h, even for entry-level models, without compromising the longitudinal distribution. Drive is provided by the Flex shaft.

### Advantages of SpeedShaft:

- ✔ Maintenance-friendly, as all components are provided with life-long lubrication
- ✔ Output increase of up to 25% compared to other mechanical systems
- ✔ Smooth running, even at high working speeds of up to 12 km/h

## ElectricDrive electric drive on the Precea Super

The ElectricDrive option provides a separate electric motor for each overpressure singling unit. The desired seed rate, fertiliser rate and the micro-granular applicator can thus very conveniently be controlled via the terminal. One activation button per sowing unit makes it possible to check the centralised singling disc.

### Advantages of ElectricDrive:

- ✔ Accurate sowing in wedges and on the headland in combination with the automated part-width section control
- ✔ Flexible increase of the seed rate to each coulter
- ✔ Working speeds of up to 15 km/h
- ✔ Activation buttons for checking the centralised singling disc

- ✔ ElectricDrive electric drive with working speeds of up to 15 km/h



# The PreTeC coulters

The all-round coulters for any soil type

## Maximum flexibility

The PreTeC mulch sowing coulters are excellently suited for precision sowing, whether after the plough, mulch sowing or direct seeding. Benefit from the first-class, consistent seed placement accuracy and use it to increase your yield. The Precea facilitates high work rates due to its high accuracy, in particular at high working speeds of up to 15 km/h.

## Even field emergence

The mulch sowing coulters (weighing 120 kg on its own) can be pressed down further by a spring with a maximum force equivalent to 200 kg. Via a hydraulic cylinder, coulters pressures of up to 400 kg are possible. This ensures smooth running and even field emergence under the hardest of conditions. The complete mulch seeding coulters are reliably guided by two large carrying rollers. Soil opening is performed by a double disc unit, including a furrow former. Once the seed has been embedded in the soil by the catcher roller, the V-pressure rollers follow to close up the furrow again.

## The unbeatable Duo – furrow former and catcher roller

The furrow former and the catcher roller ensure optimal soil contact. Good soil reconsolidation further ensures a high capillary water draw.

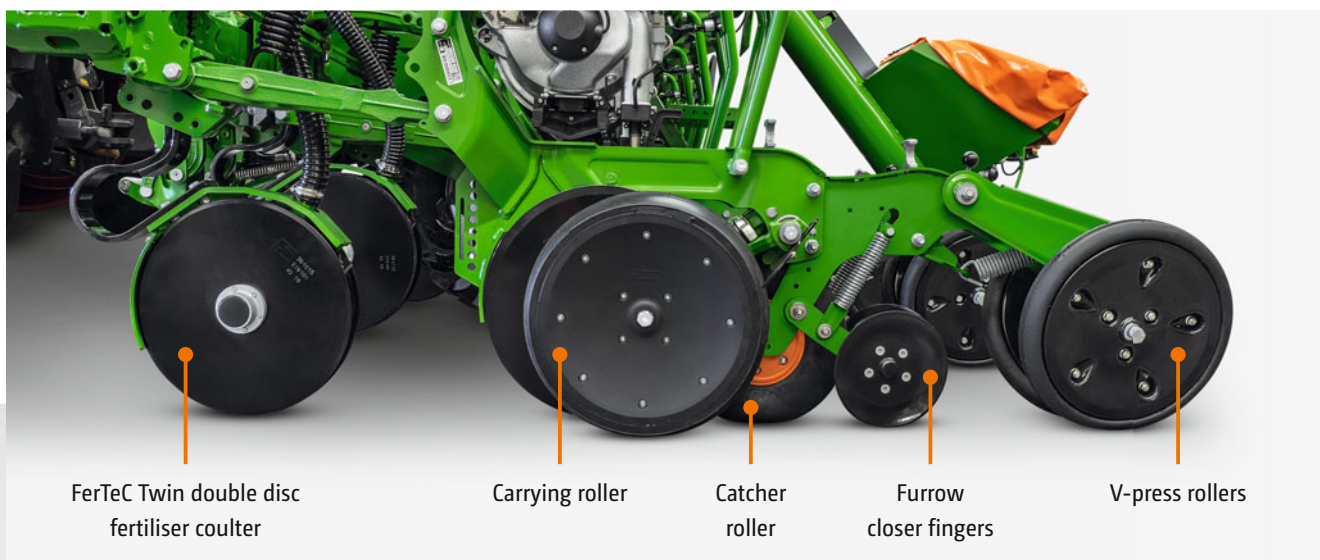

The PreTeC coulters facilitate maximum precision as well as maximum output.





## Maximum operational comfort

The good accessibility of the coulters ensures high operating comfort. A multitude of adjustment options allow adaptation to all requirements.

### The benefits:

- ✓ Higher yields and increase in the seeding quality due to reliable singling
- ✓ More adjustment comfort due to tool-free operation
- ✓ Higher flexibility due to the extensive range of optional equipment for the all-round coulters

The PreTeC coulters can be adjusted without tools! Clear, embossed adjustment instructions explain each function!

The following settings can be adjusted without tools:

- ① Coulters pressure
- ② Sowing depth
- ③ Furrow closer fingers
- ④ Contact pressure of press roller
- ⑤ Running angle of press roller



- ❗ "The scales are directly embedded into the component and do not require adhesive labels – very elegant."

("profi" – Driving report for Precea 4500-2CC Super · 10/2019)

- ❗ "Easily accessible levers with proper handles are provided for all the common adjustments at the rear of the unit."

("profi" – Driving report for Precea 4500-2CC Super · 10/2019)



# One coulter – so many possibilities







- ✔ The height of the optional furrow closer finger can be adjusted without tools

## Furrow closer fingers

The optional furrow closer finger closes the seed furrow, in particular under difficult conditions, and thus ensures optimal field emergence.

- ✔ Optimisation of the field emergence through reliable closure of the seed furrow
- ✔ Simple and tool-free height adjustment and deactivation

## Clod clearer – the ideal option against clods and stones

The optional clod clearer is the ideal tool for heavy soils and cloddy conditions. The use of a clod clearer makes the coulter run significantly more smoothly.

- ✔ Smooth coulter running in a cleared seed furrow ensures an even field emergence
- ✔ Universal adjustment of the clod clearer possible



25 mm  
smooth

50 mm  
smooth

50 mm  
toothed

- ✔ 25 mm and 50 mm press rollers are available

## Different V-press rollers

The narrow 25 mm press roller is ideal for medium to heavy soils, while the 50 mm press roller is better suited to light soils. The toothed 50 mm press roller is recommended for its particularly good reconsolidation and crumbling.

- ✔ The right roller for every soil type
- ✔ Simple and tool-free adjustment

## Star clearer – the perfect option against harvest residues

Using the optional star clearer ensures that the seed furrow is always optimally cleared, even when larger amounts of organic material are present. The trash-free seed rows ensure that the sowing coulter works well, suppresses weed regrowth and ensures optimal field emergence.

- ✔ Optimisation of the field emergence by an optimally cleared seed furrow



# Fertilising

Fertiliser metering to perfection



- ✔ The optional filling auger facilitates convenient filling of the fertiliser hopper

Fertiliser hoppers of 950 l or 1,250 l equip the Precea with sufficient capacity. The hopper is located well forwards and thus provides an optimal centre of gravity near the tractor. Steep hopper walls guide the fertiliser safely to the metering unit and keep the residual volumes low. Operation and adjustment are performed centrally, on the left side of the SmartCentre.

#### The benefits:

- ✔ Convenient access, ideal also for filling with Bigbag or via a front end loader bucket
- ✔ Low lifting power requirements due to optimal centre of gravity of the machine
- ✔ Simple filling due to generously dimensioned hopper opening
- ✔ Large sight glass





- ✔ Good accessibility of the fertiliser hopper, the roll-over cover and the large filling opening make the filling process very convenient

## Precis fertiliser metering system – air support to every row

The Precis fertiliser metering system equips the Precea with an accurate and reliable metering drive. Air support further ensures an equal feed to each row and reliably prevents blockages. The fertiliser granules are reliably conveyed to the FerTeC Twin double disc counter.

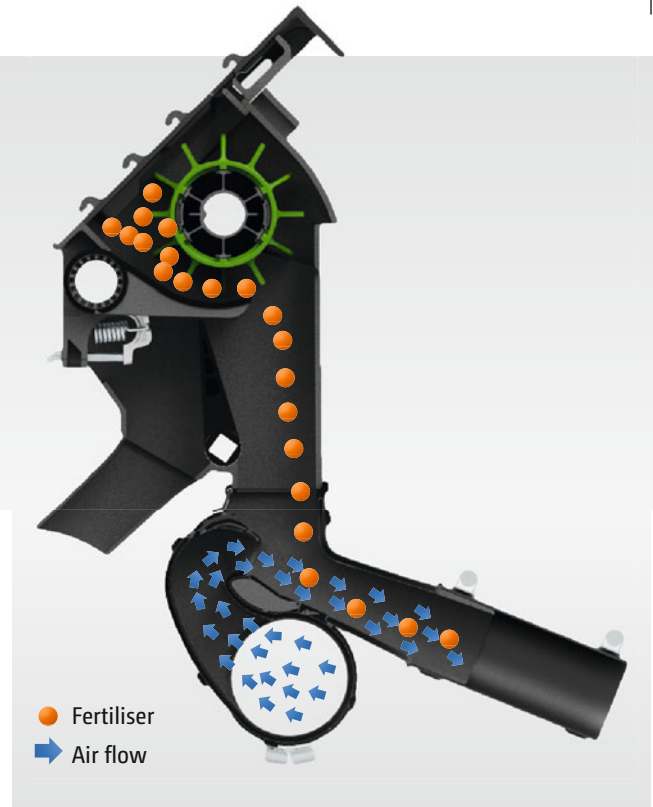

### The benefits:

- ✔ High work rates
- ✔ Comfortable change of the seed rate
- ✔ Minimisation of any downtime
- ✔ Even feed to all sowing coulters

## Mechanical fertiliser metering drive for the Precea Special

The mechanical drive with the stepless Vario-gearbox permits very simple and central setting via the SmartCentre on the machine.

### Advantages of the mechanical fertiliser metering drive:

- ✔ Convenient setting of the Vario gearbox on the SmartCentre
- ✔ Simple calibration of the application rate on the SmartCentre



## Electric fertiliser metering drive for the Precea Super

The electric fertiliser metering drive ensures maximum convenience with maximum precision. The drive is perfectly matched to the Terminal or TwinTerminal, thus working and adjustment are simple and convenient.

### Advantages of the electric fertiliser metering drive:

- ✔ Convenient setting and adjustment via the operator terminal
- ✔ Convenient calibration by using the calibration button on the SmartCentre





# FerTeC Twin double disc fertiliser couler

The high-capacity fertiliser couler



The FerTeC high-capacity double-disc fertiliser couler is suitable for after the plough, mulch or direct seeding



## Smooth running, rugged and reliable

The high-capacity double disc coulters ensure clean and reliable placement. The double disc coulters run smoothly and deposit the fertiliser in front of the PreTeC mulch coulters. The double disc coulters are completely maintenance-free and fulfil the highest requirements.

### The benefits:

- ✔ Educated soil throw ensures a very smooth running
- ✔ High service life due to the rugged and proven large-area seeding technology
- ✔ Stepless working depth adjustment
- ✔ Exchangeable guard plate



FerTeC Twin double disc fertiliser coulters



# Micro micro-granular applicator

Highest precision, even with small quantities







Micro micro-granular applicator with distribution point in the row



Micro micro-granular applicator with distribution through a diffuser

The micro-granular applicator with its 17 l hopper capacity and 3 different metering rollers provides point-accurate application for a variety of application materials. The micro-spreaders can be used for distributing micro-nutrients, insecticides, slug pellets, etc.

The granules can be distributed at various entry points. The micro-granules are distributed directly in the seed row, together with the singled seed. A diffuser that applies the granules above the closed furrow is a further option for applying micro-granules.

The attachment directly to the coulters allows for integration of the entry points into the automated part-width section control. The quantity applied can also be controlled using application maps.

**The benefits:**

- ✔ Flexibility of the application due to different entry points
- ✔ Convenient operation due to full integration into the ISOBUS machine control
- ✔ Yield optimisation due to rate control using application maps



Coulter unit with micro-granular applicator

# Precea – without compromise

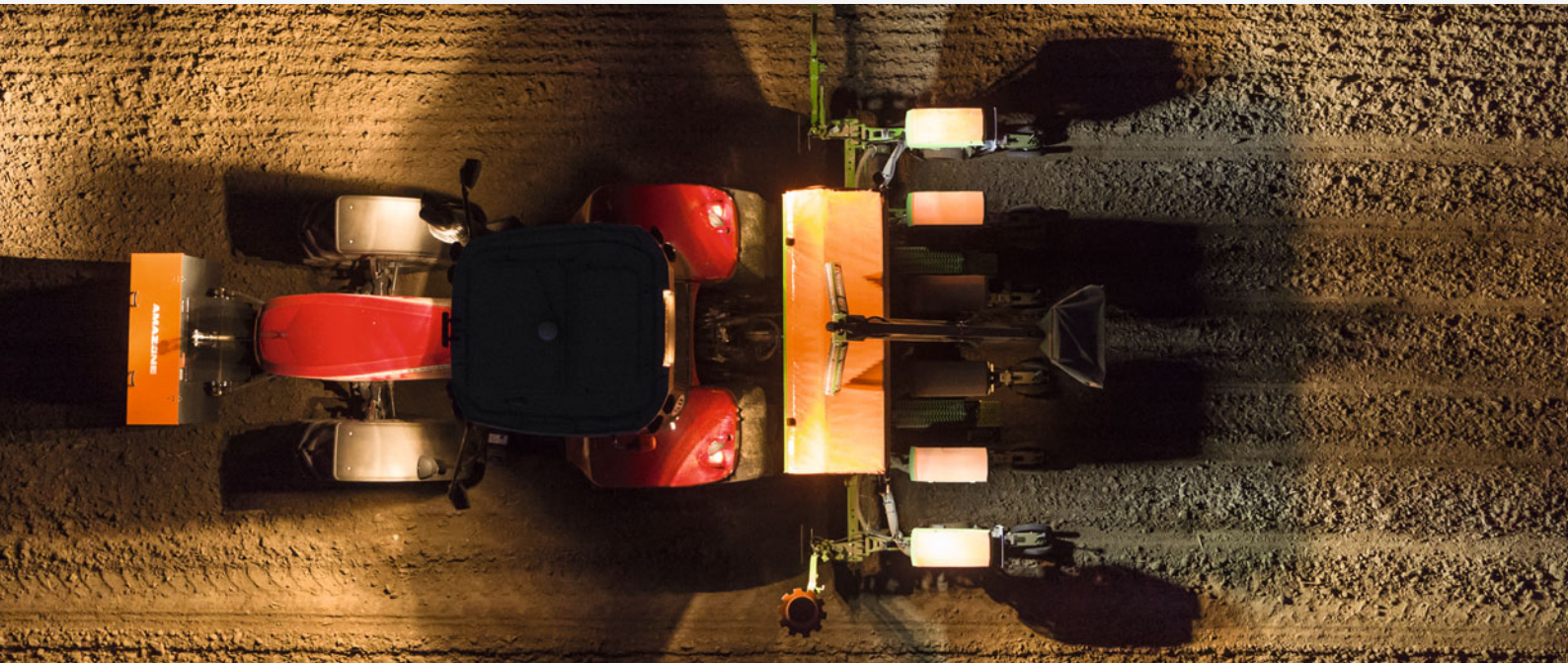

Precea 4500-2C

## Different fan drives

### Mechanical fan drive:

The mechanical fan is driven directly by the power take-off. Problem-free operation is also possible with tractors that have a low hydraulic capacity.

### Convenient, hydraulic fan drive:

The hydraulic fan drive facilitates convenient fan speed adjustment and thus ensures even longitudinal distribution, even in undulating terrain. The fan speed is set conveniently and independently from the engine speed, so that the revs always remain constant and run in the optimal range.

## Air intake cover

Optional air intake covers are available for particularly dusty conditions, as any ingress of dirt and dust can effectively block the sensitive singling process.

### The benefits:

- ✔ Prevents ingress of dirt and dust into the singling system



# Reliable to the last detail

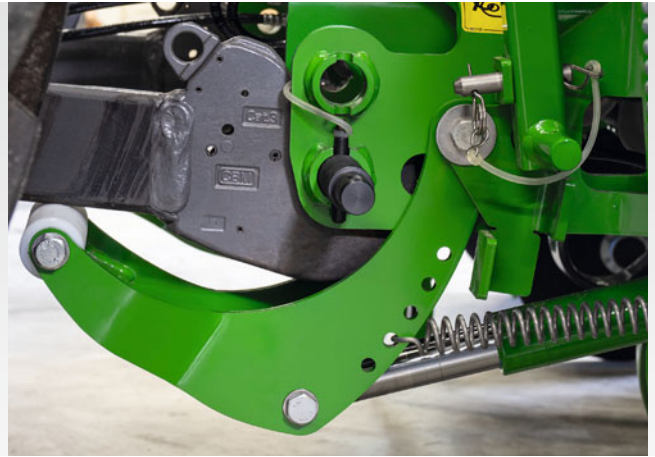

## Lights for road travel

The Precea lighting for road transport fulfils all road traffic requirements concerning transport safety. As an option, the Precea can also be equipped with LED lighting for road travel which also includes internal hopper lighting.

## LED work lights – night becomes day

Optional work lights on the seed hopper provide excellent visibility for the operator at night. By pivoting the LED lights, the working range to the side and behind the sowing combination can be optimally lit. In addition, as option, LED work lights for the sowing coulters are available which illuminates the coulters area. All work lights can be switched on conveniently via the terminal.

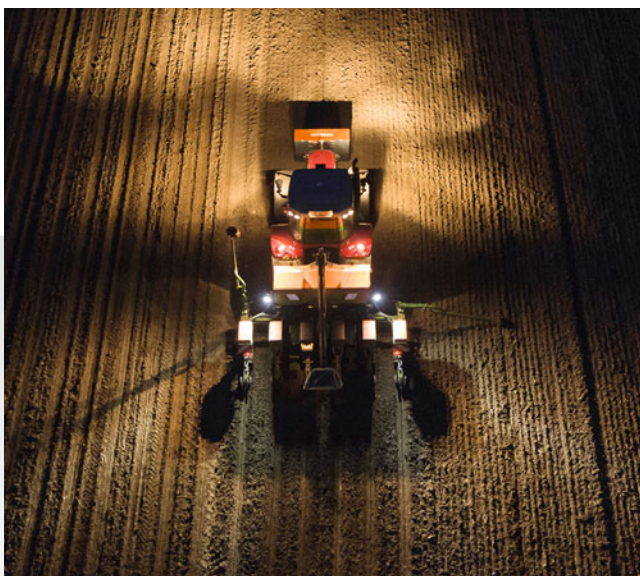

## Frame ballasting

The optional frame ballasting system allows stepless weight transfer from the tractor cab. Up to 600 kg is available when the machine is almost empty to ensure that the coulters can maintain that first-class work.

### The benefits:

- ✔ Even placement, even when the fertiliser hopper is running empty
- ✔ Comfortable handling

## HD tractor wheel mark eradicators

The optional HD tractor wheel track eradicators are useful for when on compaction-sensitive soils and for reduced working depth. Overload protection ensures a constant trip force in all positions.

### The benefits:

- ✔ Intense loosening directly behind the tractor track
- ✔ High flexibility with 3 point versions
- ✔ Vertically and horizontally adjustable



Narrow share, diamond share and wing share

- ✔ Tractor wheel track eradicator for loosening compacted wheel marks



# Operation made easy!



Precea 4500-2CC precision air seeder in work





## Standard hydraulics and comfort hydraulics

Depending on the choice made, the hydraulic system is available in two versions. There is the entry-level standard hydraulics, where every function has to be actuated from the spool valve on the tractor. For tractors with a limited number of spool valves, the Comfort hydraulics can be selected. Here the functions of wing and track marker folding can be combined via an electric changeover valve supplied by one spool valve.

### Advantages of the comfort hydraulics:

- ✔ Only 1 spool valve required
- ✔ Increased operational comfort
- ✔ Simple and fast change of any function

## AmaCheck – the alternative without ISOBUS

The AmaCheck in-cab terminal was developed specifically for operation with the Precea Special and mechanical singling drive and mechanical fertiliser metering unit. No ISOBUS system is required on the tractor. The terminal is very clearly arranged and can be conveniently operated. The AmaCheck can be used to control and monitor both mechanical drives simultaneously.

### Functions of the AmaCheck:

- ✔ Controlling the mechanical singling drive
- ✔ Monitoring the seed placement accuracy
- ✔ Controlling the Precis mechanical fertiliser metering unit
- ✔ Fill level monitoring
- ✔ Speed display
- ✔ Hectare meter



AmaCheck machine-specific terminal for monitoring the Precea precision air seeder without the ISOBUS

# ISOBUS –

Machine operation in the digital age

MEMBER OF



## One language, many benefits!

AMAZONE offers state-of-the-art technology with virtually unlimited possibilities with every ISOBUS-compatible machine. It makes no difference whether you use an operator terminal by AMAZONE or an existing ISOBUS terminal in your tractor. ISOBUS indicates a global standard for communication between the operator terminal, tractors and connected implements, on the one hand, and agricultural office software on the other.

## Operation with a wide variety of ISOBUS terminals

This means that you can control all your ISOBUS-compatible equipment using a single terminal. You only have to connect the machinery to the respective ISOBUS terminal and the usual operator interface appears on the monitor in your tractor cab.

### Benefits of ISOBUS:

- ✔ International standardisation provides uniform interfaces and data formats, meaning that compatibility with other vendors is ensured
- ✔ Plug and Play between the machinery, tractor and other ISOBUS equipment





# AMAZONE – more than just ISOBUS

Improved control, more yield! Precision Farming 4.0

## Our competence in electronics

To increase the operational convenience, AMAZONE implements and operator terminals feature a function scope far beyond ISOBUS standards.

### The benefits of more than just ISOBUS:

- ✔ Highest compatibility and safety function of your ISOBUS equipment
- ✔ No additional modules on the machine. All ISOBUS machinery by AMAZONE is already equipped as standard with the necessary ISOBUS functions.
- ✔ MiniView display with all AMAZONE terminals and additional ISOBUS terminals. See, for instance, the machine data in the GPS view.
- ✔ The possibility of using the tractor terminal or in a twin terminal solution to separate the functionalities of tractor and connected implement.

- ✔ Unique operation concept. Freely-configurable displays and individual user interfaces in the operator terminal
- ✔ Up to 3 user profiles are possible. Establish for each driver or operation an individual user profile!
- ✔ Freely-configurable machine operation as, for instance, the folding procedure of the booms of your AMAZONE crop protection sprayer
- ✔ Intelligent tractor-ECU function evaluation. Automatic motion sequence detection such as the automatic locking of a steering axle when reversing.
- ✔ Integrated TaskController data logger. As a matter of principle, every ISOBUS telemetry solution is possible (for example, TONI telemetry by CLAAS).
- ✔ Freely-configurable part width sections



# Make full use of the possibilities

## Job management and documentation

All ISOBUS terminals by AMAZONE can record and save both machine data and location-based data via the Task Controller, as standard. The collected data can then be used in your Farm Management Information System.

- ✔ Create or load jobs with ease
- ✔ Processing jobs
- ✔ Document and export the work done
- ✔ Processing of application maps in an ISO-XML format

## GPS-Track

The GPS-Track parallel steering aid proves to be an enormous aid for orientation in the field, especially also on grassland or fields without tramlines. It features various track modes such as A-B line and contour line driving. The deviation from the ideal line is graphically displayed via an integrated light bar. Thanks to the clear steering recommendations with exact tramline distances you always remain in the track.

- ✔ With a virtual light bar in the status line
- ✔ Equipped as standard for AmaPad 2
- ✔ Optional for AmaTron 4

GPS-Track – your parallel driving aid in the field

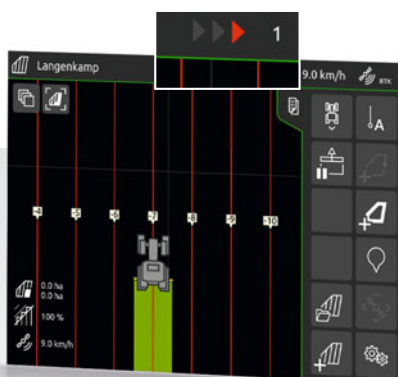

## GPS-Maps

GPS-Maps enables uncomplicated part-area site specific management because this software module provides easy use of application maps in a Shape file format. Here, either the required rate of the actual material to be spread or also the required active ingredient rate can be directly processed.

- ✔ Intuitive system to process application maps
- ✔ Automatic part-area, site specific regulation of the application rate
- ✔ Optimum crop management via need-oriented application
- ✔ Equipped as standard for AmaTron 4 and AmaPad 2



GPS-Maps – part-area, site specific application

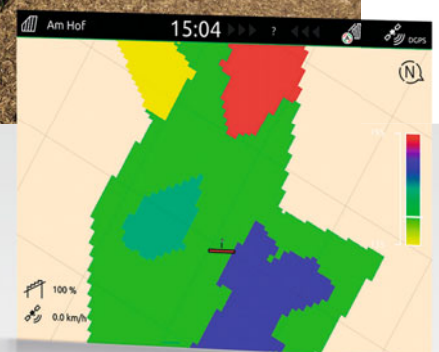



# agrirouter –

## The independent data hub for agriculture



### Simple and secure data exchange

AMAZONE opens the way to universal data exchange by means of the manufacturer-independent agrirouter. The agrirouter enables data to be exchanged between AMAZONE machinery, agricultural software, manufacturers and companies both securely and without any complications.

#### Benefits of the agrirouter:

- ✓ Uncomplicated and easy handling
- ✓ Convenient and high-speed transmission
- ✓ Full control of your data
- ✓ Data is transported, not stored
- ✓ Manufacturer-independent use

### Full control – Decide for yourself!

The agrirouter simplifies data exchange by allowing job data and application maps to be exchanged wirelessly with AMAZONE machines. This simplifies operational procedures, reduces administration time and improves efficiency. In this respect, you are the only one who has data sovereignty and can decide who receives which data and to what extent.

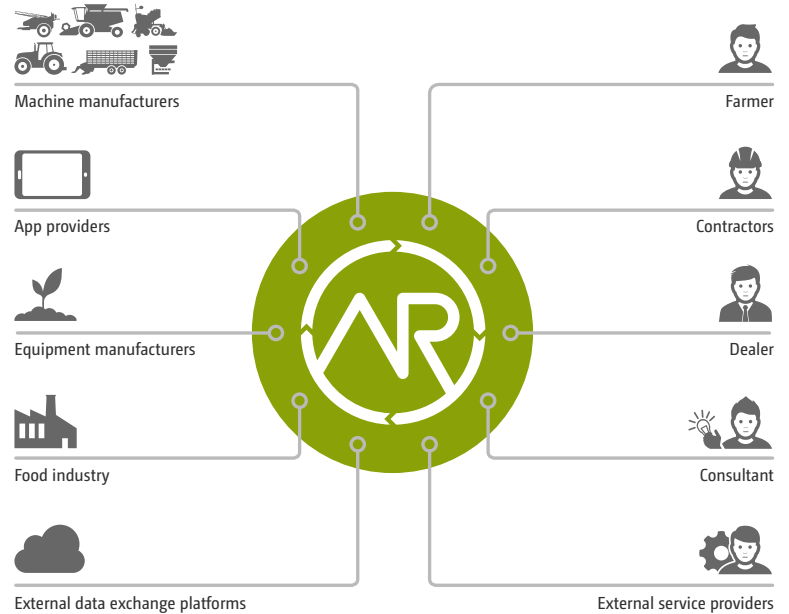

Source DKE-Data GmbH & Co. KG



AMAZONE implements the connection to the ISOBUS machinery via the AmaTron 4

# Automatic GPS-Switch part-area shut-off with Section Control

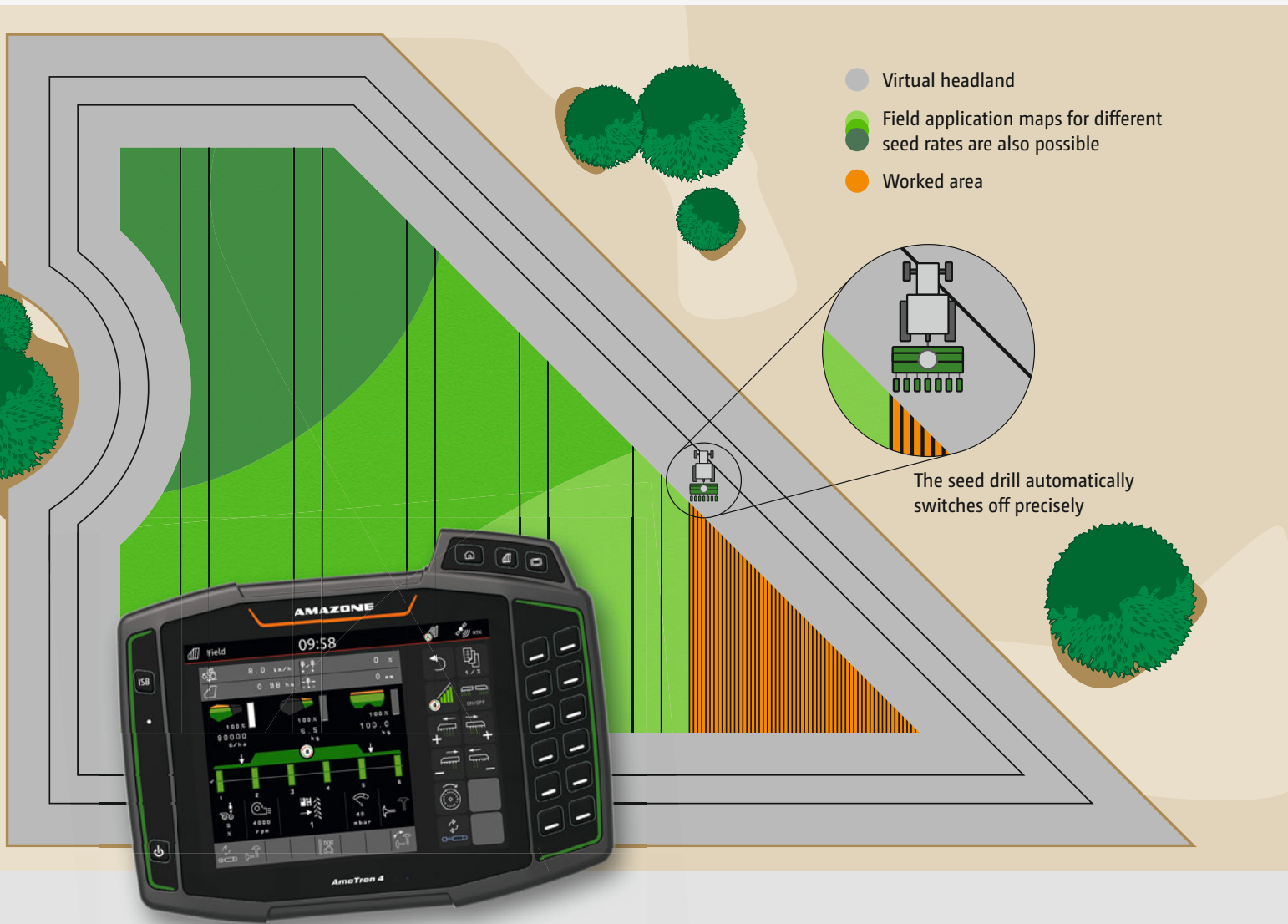

## Accurate placement of the seed

Accurate sowing is very important to avoid excessive or insufficient seeding in critical places, which is very common in practical applications. The automated part-width section

control offers a solution for accurate seed placement, as it can automatically switch each coulter on and off and thus achieve significant savings in wedges and on headlands.



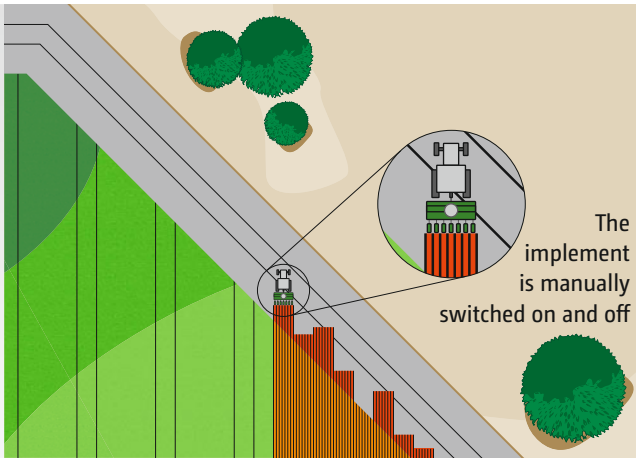

Over or under-sowing with manual on/off control without GPS-Switch

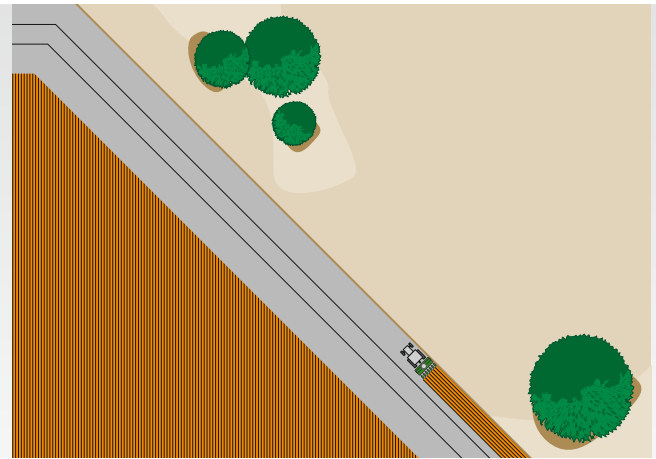

Position-dependent, automatic switching on and off of each seed row using a GPS-Switch

## Automatic part-width section control

If the terminal to be operated features Section Control, such as, for example, GPS-Switch part-width section control from AMAZONE, the switching of the part-width sections can be carried out completely automatically and in relation to the GPS position. Once a field has been established by the driver, then, in the automatic mode, they can fully concentrate on handling the vehicle whilst the switching of the part-width sections in wedges and on the headland is carried out automatically.

### Benefits of the automatic part-width section control:

- ✔ Stress relief on the driver
- ✔ Increase in precision especially at night or at higher speeds
- ✔ Less overlaps and gaps
- ✔ Saving of resources
- ✔ Less crop damage and environmental impact

❗ “With Section Control, the ISOBUS terminal takes over much of the work from the driver.”

(“dlz agrar magazine” – test report ZA-TS fertiliser spreader · 02/2017)

## GPS-Switch

With GPS-Switch, AMAZONE offers a GPS-based, fully automatic, part-width section control for all AMAZONE operator terminals and ISOBUS compatible fertiliser spreaders, crop protection sprayers or seed drills.

### GPS-Switch basic

- ✔ Automatic part-width section control of up to 16 part-width sections
- ✔ Optional for AmaTron 4

### GPS-Switch pro

- ✔ Automatic part-width section control for up to 128 part width sections
- ✔ Creation of a virtual headland
- ✔ Creation of Point of Interests (POI)
- ✔ Automatic boom lowering on an AMAZONE crop protection sprayer
- ✔ Equipped as standard for AmaPad 2
- ✔ Optional for AmaTron 4

# ISOBUS terminals from AMAZONE

Intuitive, comfortable, better – workday made easy

## From simple to high-tech – everything is possible

With the ISOBUS-compatible AmaTron 4 and the AmaPad 2, AMAZONE offers two extremely convenient operator terminals for your ISOBUS machinery. In addition to the pure machine operation, even more application possibilities are available, such as, for example, the automatic GPS-Switch (Section Control) part-width section control.

- ✔ All applications come pre-installed and can be initially tested free of charge.
- ✔ Intuitive and clear actuation

## Everything in view with the 2 terminal solution

In addition to the possibility of operating the AMAZONE ISOBUS machinery via the tractor terminal, there is the practical alternative of separating the functions of the tractor and the connected implement and operating them via two terminals. The tractor terminal can continue to control the tractor or also display the GPS applications whereas the additional operator terminal in its UT display mode is fully utilised to monitor and control the machine.



| Terminal  | AmaTron 4  | AmaPad 2   |
|---|--|--|
| Display   | 8" multi-touch colour display  | 12.1" multi-touch colour display   |
| Operation   | Touch and 12 soft keys   | Touch  |
| Interfaces  | 1 x Ethernet<br>2 x RS232 (GPS & ASD)<br>2x USB interfaces   | 1 x Ethernet<br>2 x RS232 (GPS & ASD)<br>2x USB interfaces with WLAN stick |
| Job management and processing of application maps (ISO-XML and Shape)   | GPS-Maps&Doc<br>with integrated Task Controller  | Task Controller  |
| Parallel steering aid   | GPS-Track *<br>with virtual light bar  | GPS-Track pro<br>with virtual light bar                                    |
| Automatic track guidance  | –  | GPS-Track Auto<br>for the Pantera self-propelled crop protection sprayer   |
| Automatic part-width section shut-off (Section Control)<br>Note: Bear in mind the max. no. of part-width sections of the implement! | GPS-Switch basic *<br>with up to 16 part-width sections<br>or GPS-Switch pro *<br>with up to 128 part-width sections | GPS-Switch pro<br>with up to 128 part-width sections                       |
| Camera connection   | 1x camera connection *<br>with AmaCam automatic reversing detection  | 2x camera connections *  |

\* = optional





## All from a single source!

Thanks to the AUX-N feature, you can operate multiple functions of the machine via AmaPilot+ or any other ISOBUS multi-function joystick.



### The benefits of AmaPilot+:

- ✔ Perfect ergonomics
- ✔ Almost every function directly controlled via 3 levels
- ✔ Adjustable palm rest
- ✔ Freely-programmable, individual key layout
- ❗ "The joystick rest comfortably in the hand."  
("dlz agrar magazine" – Test report Pantera 4502 · 02/2016)



- ❗ "The ISOBUS control is an in-house development from AMAZONE and has been designed clearly and is easily understandable. If desired, some keys can be freely allocated. Also the multi-function display can be freely selected."  
("agrarteute" magazine – test report Centaya seed drill · 06/2018)

# AmaTron 4

## Manager 4 all



### Simple and convenient operation as intuitive as your tablet

Why not handle a terminal as intuitively like a tablet or a smartphone? With this in mind AMAZONE has developed the highly intuitive and operator-friendly AmaTron 4 which offers a noticeably smoother operational process, especially when it comes to job management. AmaTron 4, with its 8" multi-touch colour display, meets the highest demands and offers you maximum user-friendliness. Via a finger swipe or via the App carousel, one quickly gets from application to application and to the clearly and simply structured operator terminal. The practical MiniView, a freely configurable status bar and an integrated light bar make the AmaTron 4 exceptionally easy and convenient to use.

#### Benefits of AmaTron 4:

- ✔ Automatic full screen mode when not being touched
- ✔ Practical MiniView concept
- ✔ Operation via touch display or via soft keys
- ✔ Especially intuitive and user-friendly
- ✔ Field-related documentation
- ✔ Practice-oriented and intelligent menu navigation
- ✔ Day-night mode

Equipped as standard with:

**GPS-Maps&Doc**



- ✔ The AmaCam automatic reversing detection system provides direct access to the reversing camera and prevents dangerous situations

- ✔ Machine operation (UT, Universal Terminal) in day and night mode



# AmaPad 2

An especially comfortable method of controlling agricultural machinery



## The new dimension of control and monitoring

With AmaPad 2, AMAZONE offers an especially high performance operator terminal. The 12.1" multi-touch colour display is particularly comfortable and fulfils the highest demands on Precision Farming. The operation of AmaPad is carried out solely via touch.

With the practical "MiniView concept", applications which aren't being actively operated at that moment but need to be monitored are clearly displayed at the side. If needs be, these can be enlarged by "fingertip" widening. The possibility of individualising a "dashboard panel" with the displays of choice rounds up the user ergonomics.

In addition to GPS-Switch pro, part-width section control with GPS-Track pro also a professional parallel steering aid with integrated light bar is installed as standard.

### Benefits of AmaPad 2:

- ✔ Large 12.1" multi-touch colour display
- ✔ Expanded MiniView concept
- ✔ Upgrade to automatic steering is possible thanks to the automatic GPS-Track Auto track guidance
- ✔ Day-night mode

Equipped as standard with:

***GPS-Maps pro***  
***GPS-Track pro***  
***GPS-Switch pro***





# Technical data





## Precea precision air seeder

| Model                                    | Precea 3000-A   | Precea 3000                         | Precea 4500                | Precea 4500-2      |                |           |
|--|---|-------------------------------------|----------------------------|--------------------|----------------|-----------|
| Equipment option                         | Super   | Special / Super                     | Special / Super            | Special / Super    |                |           |
| Frame execution                          | harrow-mounted  | rigid                               | rigid                      | single             | 2-fold         | variable* |
| Working width (m)                        | 3.00  | 2.70–3.20                           | 3.50–4.80                  | 3.50–4.80          |                |           |
| Number of sowing units                   | 4, 5, 6   |                                     | 5, 6, 7, 8                 | 6, 7               |                |           |
| Possible row spacing (cm)                | 50, 60, 75  | 45, 50, 60, 65, 70, 75, 80          | 45, 50, 60, 65, 70, 75, 80 | 60, 65, 70, 75, 80 | 60, 70, 75, 80 | 45–80     |
| Transport width (m) on 75 cm row spacing | 3.00  |                                     | 4.50                       | 3.30               | 3.00           |           |
| Transport length from (m)                | 3.05  | 2.00                                |                            |                    | 2.30           |           |
| Singling drive                           | electric  | Special mechanical / Super electric |                            |                    |                |           |
| Drive: fertiliser metering               | electric  | Special mechanical / Super electric |                            |                    |                |           |
| Operational speed (km/h)                 | 3–15  | Special 3–12 / Super 3–15           |                            |                    |                |           |
| Seed spacing                             | 3.1 cm to 86.9 cm depending on the singling disc used                                       |                                     |                            |                    |                |           |
| Singling unit                            | Singling discs<br>for maize, sunflowers, sugar beet, rape, soya, sorghum, field beans, peas |                                     |                            |                    |                |           |
| Fertiliser hopper capacity (l)           | 950   | 950 / 1,250                         |                            |                    |                |           |
| Seed hopper capacity (l)                 | 55  |                                     |                            |                    |                |           |

\* Only available in Super version

Illustrations, content and technical data are not binding! Technical data may deviate according to the level of equipment. Machine illustrations can vary due to country-specific traffic legislation.





**AMAZONE**



Illustrations, content and technical data are not binding! Technical data may deviate according to the level of equipment.  
Machine illustrations can vary due to country-specific traffic legislation.



**AMAZONEN-WERKE H. Dreyer GmbH & Co. KG**  
P. O. Box 51 · 49202 Hasbergen-Gaste/Germany  
Phone +49 (0)5405 501-0 · Fax +49 (0)5405 501-193